



# **STORAGE & ACCESSORIES**

## A COMPLETE GUIDE



# TABLE OF CONTENTS

## STORAGE

Pedestals .....	4
Mobile Pedestals.....	6
Low Storage.....	8
Storage Towers .....	10
Lateral Files .....	12
Overhead Storage.....	14

## ACCESSORIES

Monitor Arms .....	16
LED Task Lights .....	18
Power & Data Units .....	20
Wire Management .....	22
Pencil Drawer.....	23
Coat Hooks.....	23
Paper & Accessory Trays .....	24
Keyboard Trays .....	26
Tablet Arm.....	28
CPU Holders .....	28
Tack Boards .....	29
Marker Boards .....	30

# PEDESTALS

Mount our structural pedestals under any workstation or add a freestanding pedestal to complement any office! Structural pedestals can come as either square pull or full pull fronts. The square pull pedestals are 20" deep, while the full pull pedestals can be either 21" or 23" deep. Our full pull freestanding pedestals are 20.5" D and come with tops.

## BOX-BOX-FILE PEDESTALS



Structural Box-Box-File Full Pull  
BBF-FP-21 (21" D) | BBF-FP (23" D) - No Top



Structural Box-Box-File Square Pull  
BBF-SP (20" D) - No Top



Freestanding Box-Box-File Full Pull  
BBF-FP-FS (20.5" D) - With Top

## FINISHES

Full Pull

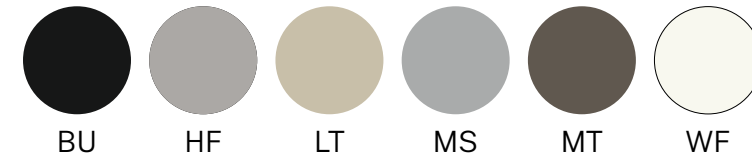

Square Pull



## FILE-FILE PEDESTALS



Structural File-File Full Pull  
FF-FP-21 (21" D) | FF-FP (23" D) - No Top



Structural File-File Square Pull  
FF-SP (20" D) - No Top



Freestanding File-File Full Pull  
FF-FP-FS (20.5" D) - With Top



# MOBILE PEDESTALS

Mobile pedestals can fit underneath your workstation, but can also be moved for easier accessibility. Add a fabric seat cushion for additional convenience! Mobile pedestals come with full pull or flush pull fronts.

Note: Seat cushions are sold separately. The Budget Mobile Pedestal is the only mobile pedestal that still fits under a work surface if a seat cushion is added.

## BOX-BOX-FILE MOBILE PEDESTALS



Mobile Box-Box-File Full Pull  
BBF-FP-MP (20.5" D)



Budget Mobile Box-Box-File Full Pull  
BBF-FP-MPB (21" D)



"Skinny" 12" W Mobile Box-Box-File Flush Pull  
BBF-FP-MP-12 (21.9" D)  
Note: Cannot be keyed alike to other storage

## FINISHES

Full Pull

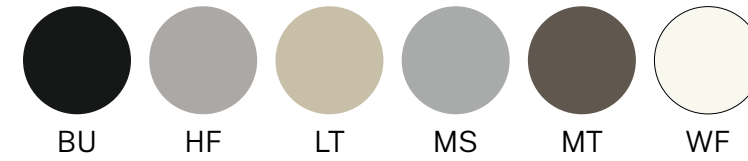

Flush Pull

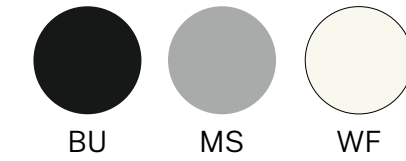

## FILE-FILE MOBILE PEDESTALS



Mobile File-File Full Pull  
FF-FP-MP (20.5" D)

Add a fabric seat cushion (sold separately) to mobile pedestals! Perfect for quick office meetings!

Note: The Budget Mobile Pedestal is the only mobile pedestal that still fits under a work surface if a seat cushion is added. 12" W "Skinny" Mobile Pedestal does not accept a seat cushion)



# LOW STORAGE

Low storage solutions that are designed to complement our Desking System! They are compatible with all of our systems.

## FINISHES

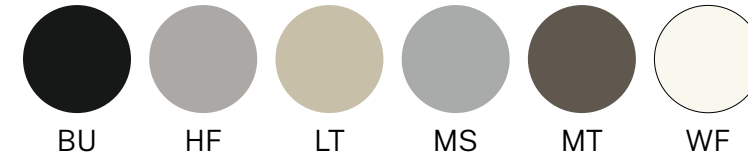

### Desking Box-File Full Pull

DS-BF-FP-M (19.7" D)

Lockable storage that includes one drawer and one file drawer. Comes only in a full pull front and standard as mobile with casters. Square legs also available upon request. Shown with optional fabric cushion (sold separately).



### Two Drawer Low Storage

DS-2D-XX-FP-M (20" D)

Lockable metal storage with one drawer and one file drawer. Also includes wire management capabilities. Available in 30", 36" and 42" widths with square legs and a full pull front. Shown with optional fabric cushion (sold separately).



### Open Shelf Low Storage

DS-SH-XX-M (20" D)

Metal storage that includes one shelf and wire management. Available in 30", 36" and 42" widths with square legs. Shown with optional laminate top (sold separately).



### Sliding Door Low Storage

DS-SD-XX-M (20" D)

Metal storage includes lockable sliding door and wire management. Available in 30", 36" and 42" widths with square legs.

Add a fabric seat cushion or laminate top (sold separately) to low storage!

Note: Laminate tops not available for DS-BF-FP-M.



# STORAGE TOWERS

Lockable storage cabinets that complement any system station.  
Available in 37", 51" and 63" heights.

**63"H TOWER**  
LFT-242463-FP-X (24" W x 24" D)



Handed L or R  
Wardrobe side  
denotes hand (Right  
shown)

## FINISHES

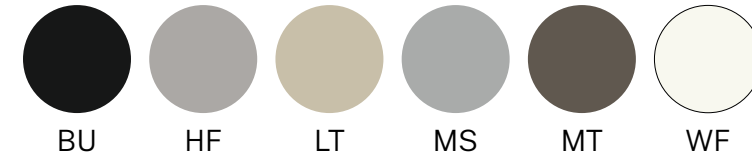

**51"H TOWER**  
DS-ST242451X-M  
(24"W x 24" D)



51"H includes  
open shelf on side

Handed L or R  
Wardrobe side  
denotes hand (Right  
shown)

**37"H TOWER**  
DS-ST242437-M  
(24"W x 24" D)



# LATERAL FILES

A lockable file with counterweight that can be used freestanding or mounted under a work surface. Accommodates legal or letter size hanging files. The full pull lateral files are available in 30", 36" and 42" widths.

## FULL PULL LATERAL FILES (2-3 DRAWER)

Available in 30", 36" and 42" widths



2-DRAWER LATERAL FILE  
LF2-XX-FP (19.7" D)

## FINISHES

Full Pull

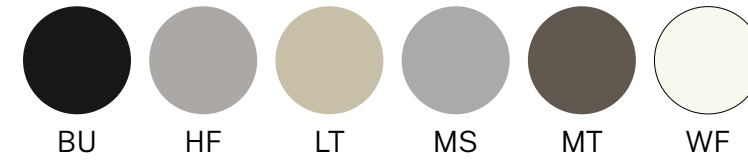

BU HF LT MS MT WF



3-DRAWER LATERAL FILE  
LF3-XX-FP (19.7" D)



# OVERHEAD STORAGE

## SLIDING DOOR UNIT

Lockable sliding door unit that attaches to panel or tile systems. Available in two styles: standard or upmount. Available in 24"-60" widths. Also available in a marker board finish.



**Standard Sliding Door**  
SDCABXX-MD

The standard sliding door installs directly to a panel and does not require a back. Door available in metal or fabric.



**Upmount Sliding Door**  
SDCABXXUM-MD

The upmount sliding door is easy to install with updated mounting brackets. Door available in metal or fabric.

## METAL OVERHEAD STORAGE UNIT

Lockable flipper door and half height shelf options. Connects to panels and is available in sizes ranging from 24" to 60". Also available in a marker board finish.



**Flipper Door**  
OHS-MFDXX

The all metal standard flipper door installs directly to a panel.



**Half Height Shelf**  
OHS-MSHXX

The all metal half height shelf installs directly to a panel.

## FINISHES



## FLIPPER DOOR UNITS

Lockable flipper doors that can be painted or upholstered. Available in A style (flat edge) or B style (radius edge) and must attach to panels of the same width. A style only available with Fabric units. Available in 24"-60" widths, with a 150 lb capacity. Also available in a marker board finish (Painted style only).

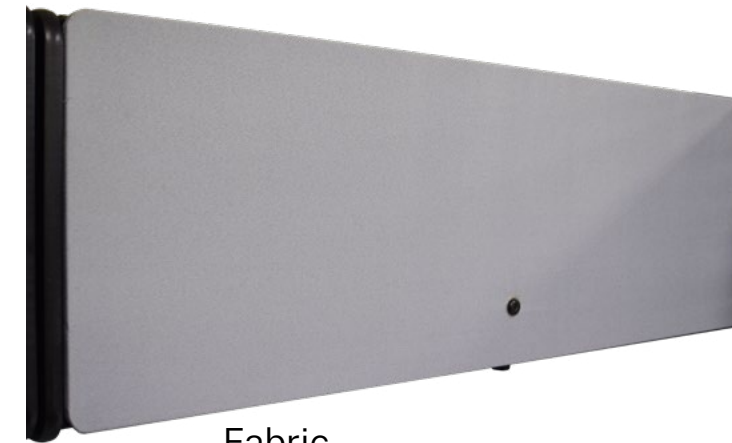

**Fabric**  
FDUXX12A | FDUXX12B  
(A-Style shown, B-Style also available)



**Painted**  
FDUXX12P  
(B-Style only)

## OPEN SHELVES

Half height and full height options available. Available in A style or B style and must attach to panels of the same width. Available in 24"-60" widths, with a 150 lbs capacity.



**Half Height Shelf**  
SHHXX12A | SHHXX12B

7.5" H and 12" D.  
NOTE: Half Height Shelves can fit on 53"H panels. 32, 39 and 47"H panels cannot accommodate shelves.



**Full Height Shelf**  
SHXX12A | SHXX12B

15" H and 12" D.



# MONITOR ARMS



## OPS-101-BUDGET

- Single Monitor Arm
- Gas spring lift
- VESA compatible mount
- Clamp or grommet mount (both included)
- 15"-27" monitor size limit
- 17.6 lbs monitor weight limit
- White with black trim



## OPS-201-BUDGET

- Dual Monitor Arm
- Gas spring lift
- VESA compatible mount
- Clamp or grommet mount (both included)
- 15"-27" monitor size limit
- 17.6 lbs monitor weight limit
- White with black trim



## OPS-301-BUDGET

- Triple Monitor Arm
- Gas spring lift
- VESA compatible mount
- Slim clamp or grommet mount (both styles available)
- 15"-24" monitor size limit
- 17.6 lbs monitor weight limit
- Can be displayed side by side or back to back
- White with black trim



## OPS-401-BUDGET

- Quad Monitor Arm
- Gas spring lift
- VESA compatible mount
- Slim clamp or grommet mount (both styles available)
- 15"-24" monitor size limit
- 17.6 lbs monitor weight limit
- Can be displayed side by side or back to back
- White with black trim



White w/  
Black Trim



Both mounting  
options included

# LED TASK LIGHT

## W/ MOTION SENSOR (24" LIGHT ONLY)

Save energy with the easily mountable LED Task Light with built-in motion sensor. Each light runs at approximately 13 watts or less, which computes to over 60% in energy savings for comparable incandescent and fluorescent lights. LEDs have been proven to last longer and use less energy than their outdated fluorescent counterparts. Our LED task light attaches to the underside of a flipper door unit or shelf using magnets for easy adjustment.

Available in silver aluminum finish. 18" and 24" options available. 24" includes a built-in motion sensor (can be toggled on/off). Lights can also be daisy-chained together.

Note: 24" light cannot be used on 24" overheads. 18" light is recommended with 24" overheads.

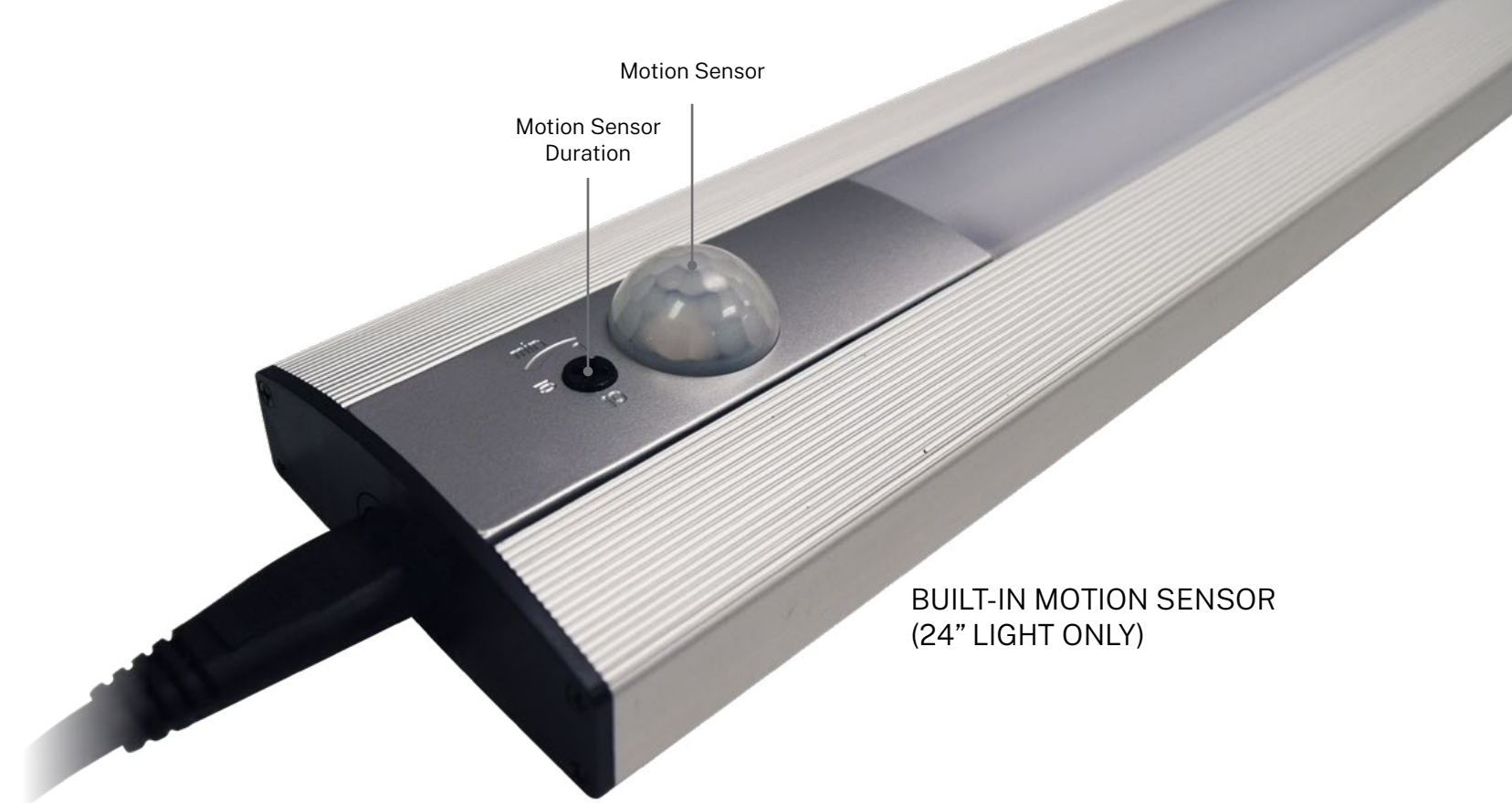

### FEATURES

Sizes	18" and 24"	Built-In Motion Sensor	24" light only
Wattage per fixture	9.8W (18") 13W (24")	Dimensions (in)	18"L x 3"W x 1"H (18") 24"L x 3"W x 1"H (24")
Lumens per fixture (18")	580 Lm-6000k	Lux	260 - 6000k
Lumens per fixture (24")	680 Lm-6000k	Lamp Life	~50,000 hours (18") ~30,000 hours (24")
Efficacy	50 Lm/W	Maximum Run (chaining)	42 fixtures
Color Temperature	6000k - White	CRI	>75
Voltage	120V AC	Housing	Aluminum
Operating Temperature	-22°F to 185°F	Environment	Indoor use, dry location
Beam Angle	120°	Mounting	Magnetic





# POWER & DATA UNITS

## Covered Data/Power Unit

OPS-D270

Add power and data to your work surface. The Covered Data/Power unit helps protect against dust and spills when not in use.

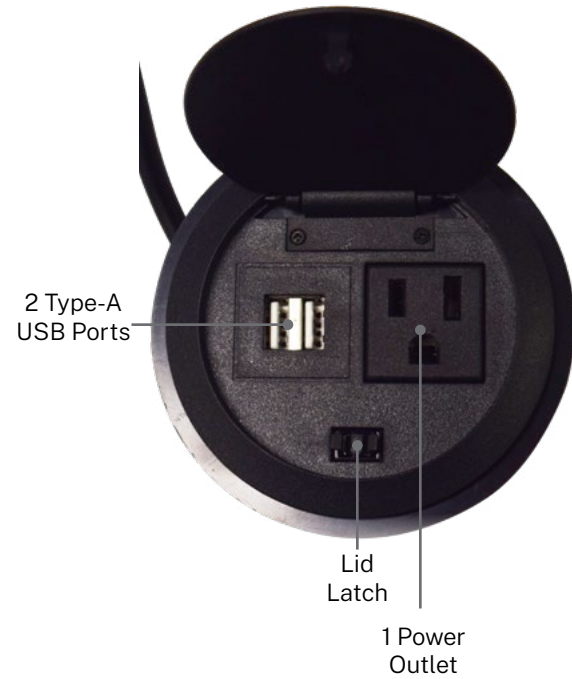

## Recessed Power Unit

OPS-TV2802-F

Easily add a recessed power unit to your work surface. Includes a 10' power cord to easily plug into a power source.

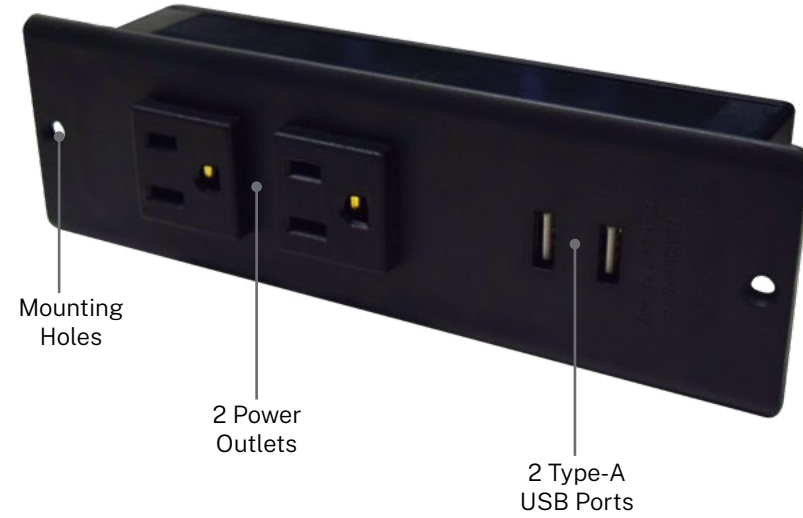

## Work Surface Power/Data Unit

FLPDMFM

Add further functionality to your work surfaces with the UL approved work surface mounted Power & Data Unit. Not compatible with CAT6.

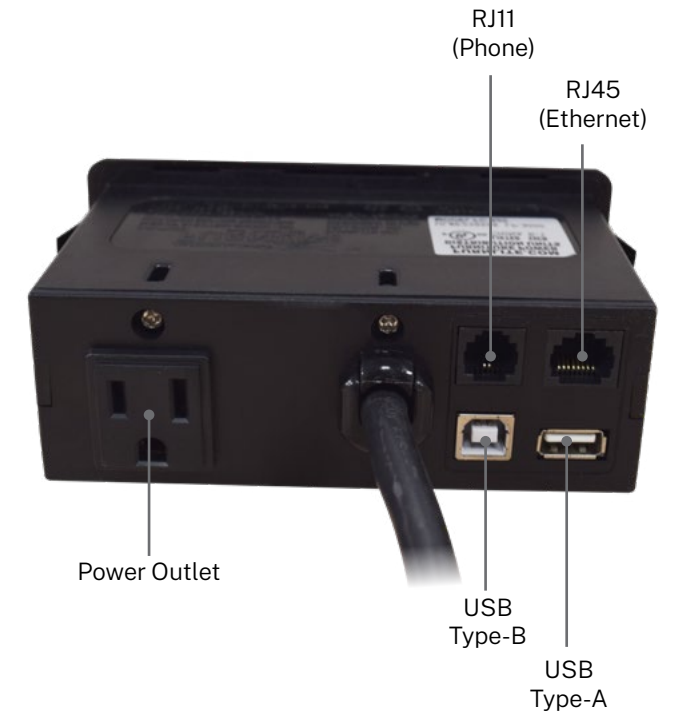
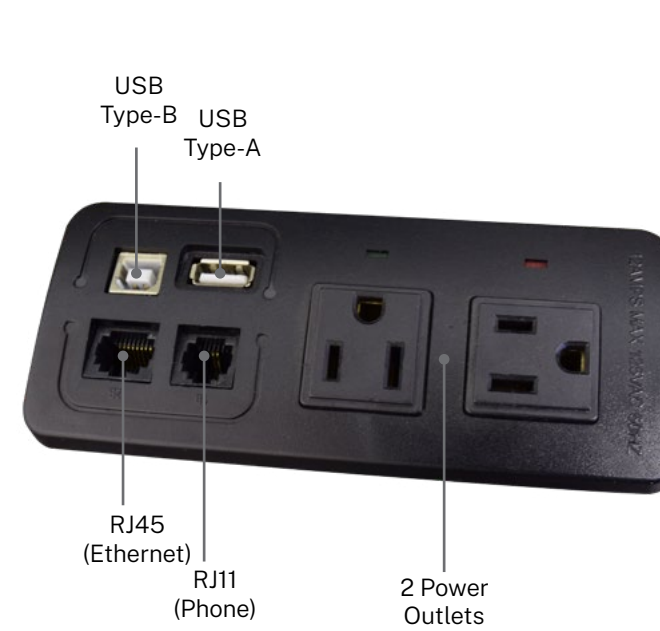

## Pop-Up Table Docks

OPS-DOC702.BK (Single) | OPS-DOC704.BK (Black Dual) | OPS-DOC704.SA (Silver Dual)

Conceal useful power and data inputs in your conference tables or standard work stations. Available in single and dual versions. Single option includes power, USB charging and Ethernet ports. Dual version includes power, USB charging and video access for easier presentations.

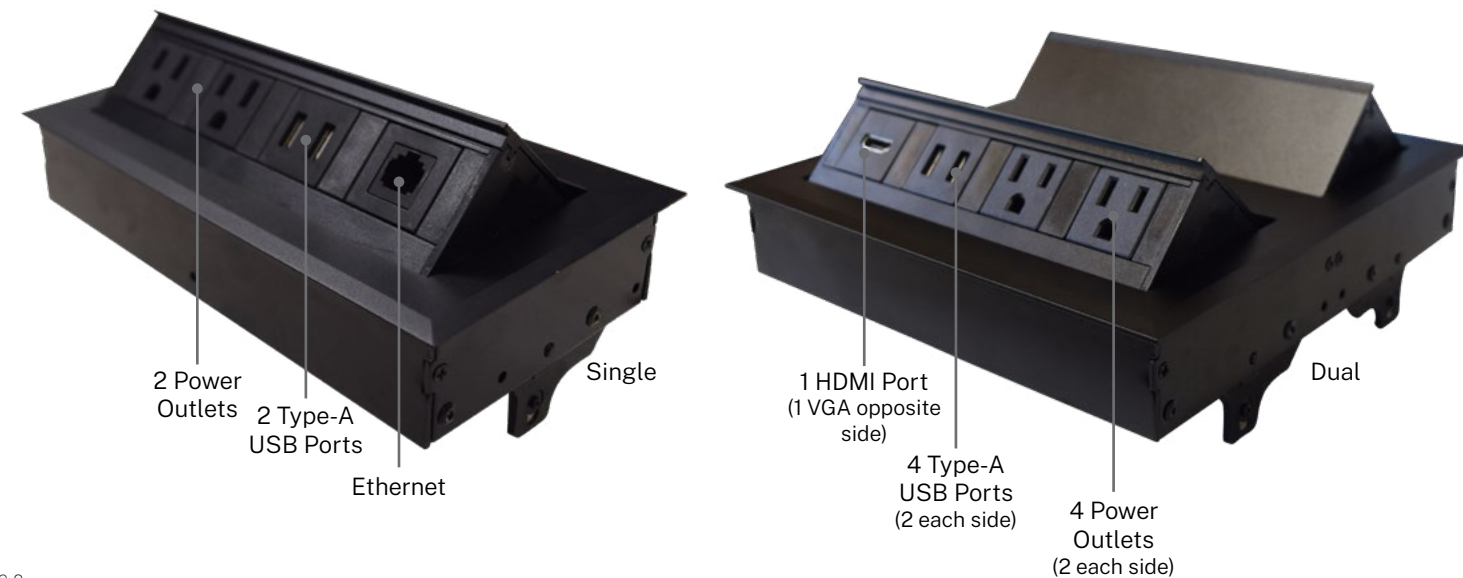

## Plug-In Clamp Mount Duplexes

XP-DUPLEX-USB-P-1.XX

Clamps to any work surface. Each includes 2 power outlets and 2 additional USB ports. Connects via power cord.



## Wireless Charger

OPS-950.BK

Charge your Qi compatible devices with our wireless charger! Fits into a work surface grommet.



# WIRE MANAGEMENT

Safely store and tuck away wires in your system stations. There are two options designed for Powered Adjustable Height Tables and traditional 30"H OPS2 Panel and Desking System stations.

## FINISHES

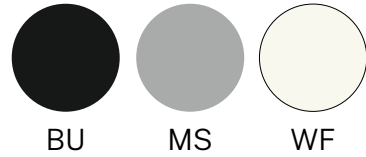

Data Wire Management 30"  
WM.XX

Designed for use with traditional 30"H OPS2 Panel & Desking System stations.

Data Wire Management 58"  
WM-E

Designed for use with Powered Adjustable Height Tables.

# PENCIL DRAWER

PDN

Keep your favorite office supplies handy and your desktop clutter-free! The pencil drawer mounts under work surfaces and is available in black.



# COAT HOOKS

Add functionality to your panels with these easy to attach coat hooks for hanging outerwear.



Metal Hook  
CH-U.XX

The metal coat hook attaches into panel rails. Available in black only.



Plastic  
CH

Easily hang your outerwear over panel systems. Available in black only.





# PAPER & ACCESSORY TRAYS

Mix and match your favorite XPand and traditional OPS2 Panel accessory trays. The accessory trays are cross compatible between both systems!



**XPand Screen Accessory Rail**  
XP-ACC-RAIL-X

Easily attaches to a XPand fabric screen and allows you to attach either standard or XPand accessory trays. Available in single, double and thin screen versions. XPand System only. See XPand Pricing Guide for all options.



**Paper Tray**  
XP-PAPER-TRAY

Attaches to a XPand Screen Accessory Rail or a Tool Rail Bar.



**Box Tray**  
XP-BOX-TRAY

Attaches to a XPand Screen Accessory Rail or a Tool Rail Bar.

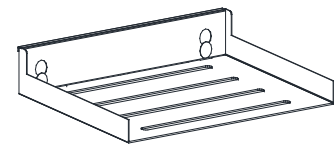

**Phone Tray**  
XP-PHONE-TRAY

Attaches to a XPand Screen Accessory Rail or a Tool Rail Bar.

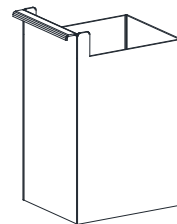

**Pen Tray**  
XP-PEN-TRAY

Attaches to a XPand Screen Accessory Rail or a Tool Rail Bar.

## FINISHES

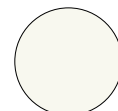

WF



**Tool Rail Bar**  
TRBX

Attaches to a panel (of equal width) and allows you to attach standard or XPand accessory trays. Have a weight capacity of 25 lbs. OPS2 Panel System only.



**Binder Holder**  
TRBBH

Attaches to a Tool Rail Bar or XPand Screen Accessory Rail.



**Diagonal Paper Tray**  
TRBDPT

Attaches to a Tool Rail Bar or XPand Screen Accessory Rail. Comes with 3 transparent dividers.

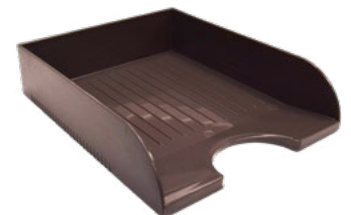

**Vertical Paper Tray**  
TRBVPT

Attaches to a Tool Rail Bar or XPand Screen Accessory Rail.

## FINISHES

### Tool Rail Bar



BU



HF



LT



MS



MT

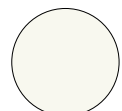

WF

### Accessory Trays



BU



MS



MT



WF

# KEYBOARD TRAYS

We offer a number of different keyboard options. Choose which one works best for you!

Note: All of our keyboard trays and track mechanisms can be used interchangeably, allowing you to create the perfect set to match your needs!



**BEST SET**  
AKABEST  
Named our best set for a reason.

**BEST SET EXTENDED**  
AKABESTEXT  
Best set with extended 12.5" arm.



**VALUE SET**  
AKAVALE  
Our deepest savings!

**VALUE SET EXTENDED**  
AKAVALEEXT  
Value set with extended 8.25" arm.



**ADJ HEIGHT TABLE SET**  
WKETABLE  
Designed for 30" and 36" D Straight  
Powered Adjustable Height Tables Only.

## KEYBOARD SET COMPARISON

SET NAME	TRAY WIDTH	TRAY DEPTH	ARM TRACK	HEIGHT ADJUSTMENT	MOUSE TRAY	WRIST PAD	TILT
VALUE SET	20"	11"	21"	5.25"	YES	YES	+/- 15°
VALUE SET EXTENDED	20"	11"	21"	8.25"	YES	YES	+/- 15°
BEST SET	20"	10.5"	21"	8"	YES	YES	+10° / -20°
BEST SET EXTENDED	20"	10.5"	23"	12.5"	YES	YES	+10° / -20°
ADJ HEIGHT TABLE SET	28.4"	10.75"	11"	5.75"	YES	YES	+10° / -20°



# TABLET ARM

WKTABLET

Mount your tablet to one of our tool rail bars using our Support Arm with Tablet Holder. Tool rail bar is sold separately and mounting hardware is not included. Wire management is also included.



# CPU HOLDERS

Strap it. Dock it. Tow it. Three low-cost solutions to keep your computer towers tucked away and instantly accessible.



**Strap System**  
WKEZCINCH

Mounts underneath work surfaces. CPUs easily slide out and swivel to allow access to wires but store easily.



**Metal System**  
WKEZCINCHMETAL

Similar to the Strap System, but made with a sturdier metal.



**Trolley System**  
WKTROLLY

An adjustable housing and wheels ensure your CPU fits securely with maximum maneuverability.

# TACK BOARDS

Post reminders and frequently referenced documents! These fabric covered tack boards attach to panel rails, and are available in different styles.



**A-Style Tack Board**

TBXX12A | TBXXA

Fabric covered A-Style Tack Board. Available in 12" and 16"H and 24"-60" W.

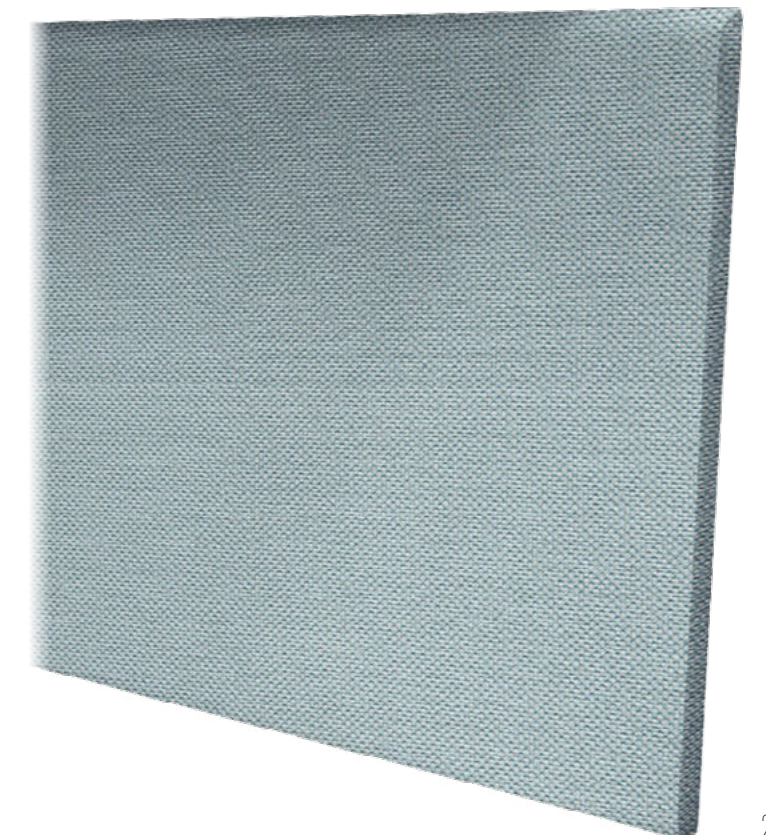

**B-Style Tack Board**

TBXX12B | TBXXB

Fabric covered B-Style Tack Board. Available in 12" and 16"H and 24"-60" W.

# MARKER BOARDS

Jot down notes during those brainstorming sessions on white dry-erase marker boards that attach to panels. Marker tray included. Available in 24"-48" boards.

## Marker Board

MBXXXX

Easily attaches to panels. Marker tray is included. Custom sizes are available.







[www.openplan.com](http://www.openplan.com) | [sales@openplan.com](mailto:sales@openplan.com) | 844.OPS.OPS1 | REV 12.13.21

© 2021 Open Plan Systems. All Rights Reserved.

*All content is subject to change. For the most current revision, visit [www.openplan.com](http://www.openplan.com).*