

















# C-LEG GRADE 1 BASE

## POWERED ADJUSTABLE HEIGHT TABLE

# ASSEMBLY & USE



## SAFETY INFORMATION

	Make sure no obstacles are in the desk's path. Make sure the desktop is not touching any walls. Make sure all cords are appropriate length to accommodate the change in height.			<b>WARNING</b> Pinch Point Keep hands and fingers clear.
	Keep children away from electric height-adjustable desks, control units and handsets. There is a risk of injury and electric shock.			
	Keep all electrical components away from liquids.			
	Do not sit or stand on the desk frame. Do not crawl or lie under the desk frame.			
	Do not place any objects taller than 20" underneath the desk.			
	Do not open any of the components - the Legs, Control Box, or Switch. There is a danger of electric shock.			
	This product is designed with a duty cycle of 10% (2 min. on, 18 min. off).			
	In the event of a power outage or if the power cord is unplugged, a manual reset may be necessary - see USE section.			

## USE & LIABILITY

This height adjustable desk has electric motors and is designed for use in dry work areas only.

The desk height is adjustable so that it can be positioned at the most ergonomically suitable height.

Any other use is at user's risk.

Under no circumstances does the manufacturer accept warranty claims or liability claims for damages caused from improper use or handling of the desk frame.

**Note:** Instruction diagrams show a T-Leg style instead of the standard C-Leg style for the Deluxe Base.

# ASSEMBLY

## TOOLS

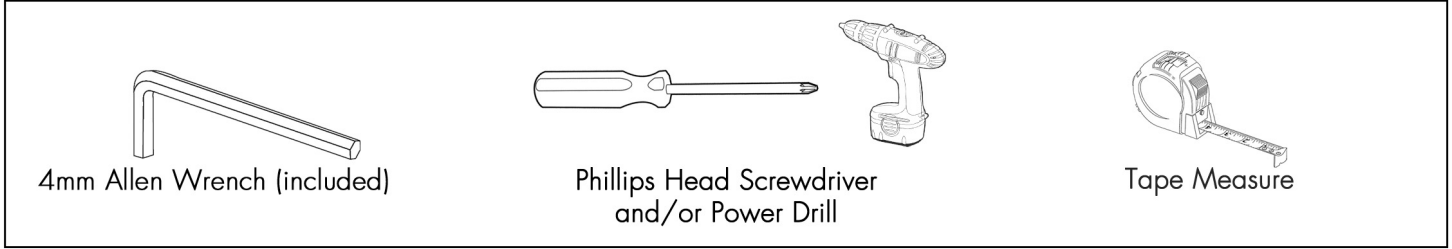

## PARTS LIST

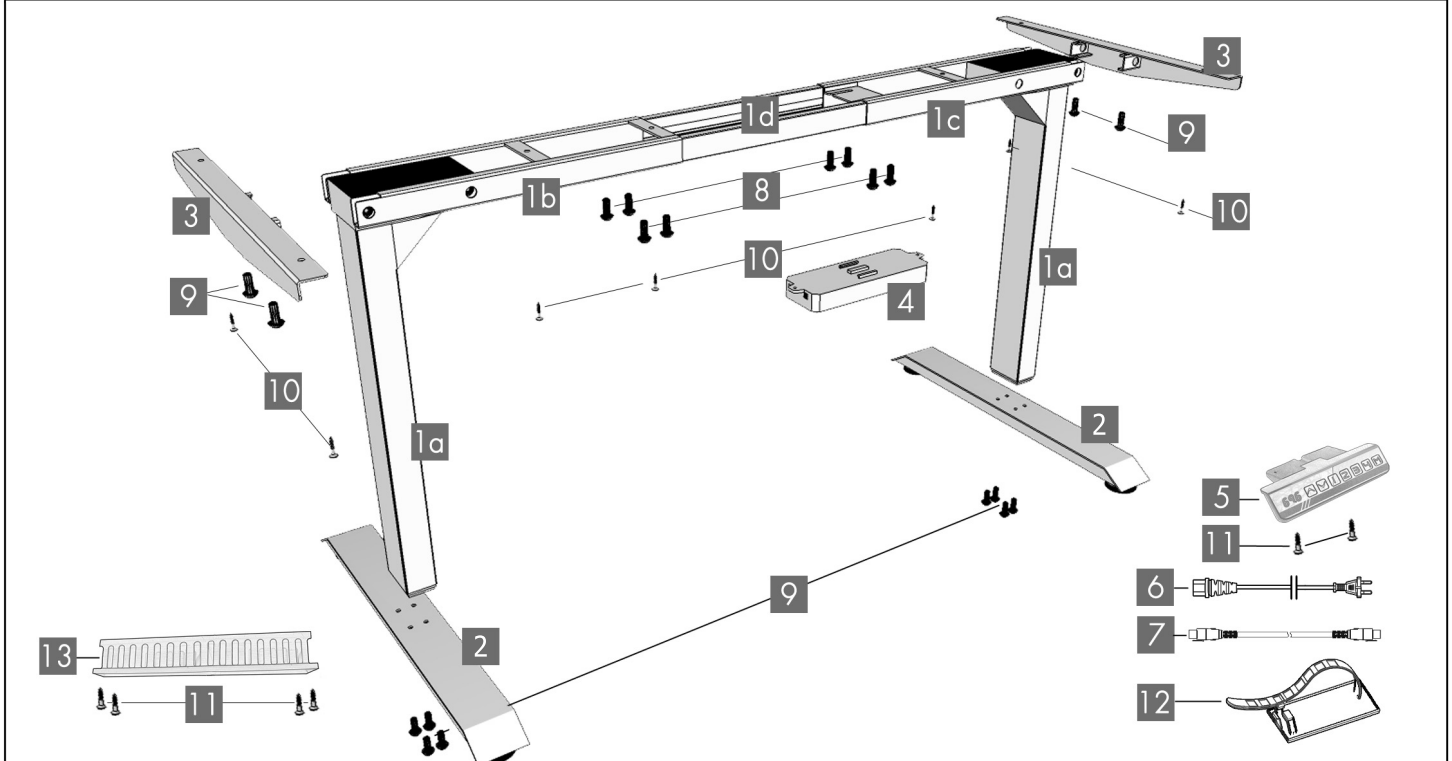

Part	Qty	Part	Qty	Part	Qty
<b>1</b> Frame-Leg Assembly (preassembled)	1	<b>4</b> Control Box	1	<b>8</b> M6x10 Machine Screw	8
<b>1a</b> Leg	2	<b>5</b> Handset	1	<b>9</b> M6x14 Machine Screw	12
<b>1b</b> Frame End	1	<b>6</b> Power Cord	1	<b>10</b> M5x20 Wood Screw	7
<b>1c</b> Frame End-CB	1	<b>7</b> Cable (1.3m)	1	<b>11</b> M5x16 Wood Screw	6
<b>1d</b> Center Rail	2			<b>12</b> Cable Clip	2
<b>9</b> M6x14 Screw	8			<b>13</b> Wire Manager	1
<b>2</b> Foot	2				
<b>3</b> Side Bracket	2				

# ASSEMBLY

**Note:** Instruction diagrams show a T-Leg style instead of the standard C-Leg style for the Deluxe Base.

- 1 Lay out all components and hardware to ensure that you have all the components and hardware listed on the parts page.

On the Frame-Leg Assembly (part 1), rotate each Leg (part 1 a) 90 degrees. You may have to loosen the four (4) preinstalled M6x14 Machine Screw Screws (part 9).

2

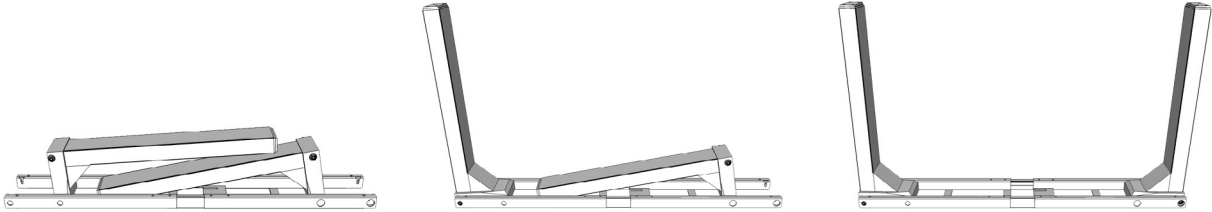

- 3 Using the supplied Allen Wrench, tighten the eight (8) M6x14 Machine Screws (part 9) in the locations shown.

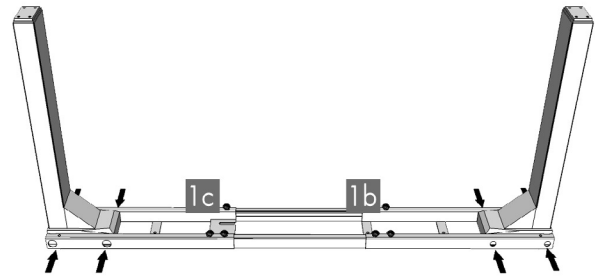

Insert the Side Brackets (part 3) into the Frame/Leg Assembly (part 1) as shown.

- 4 Using the supplied Allen Wrench, insert and tighten four (4) M6x14 Machine Screws (part 9) through the Frame Ends (parts 1 b & 1 c) and into the Side Brackets (part 3).

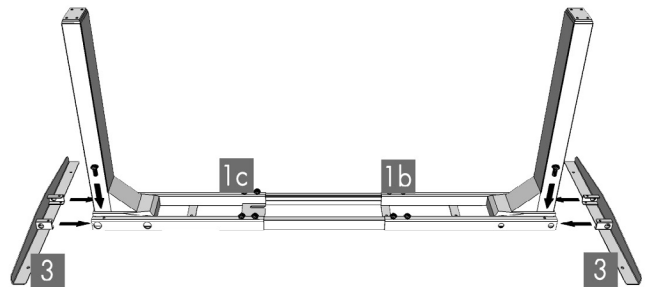

5

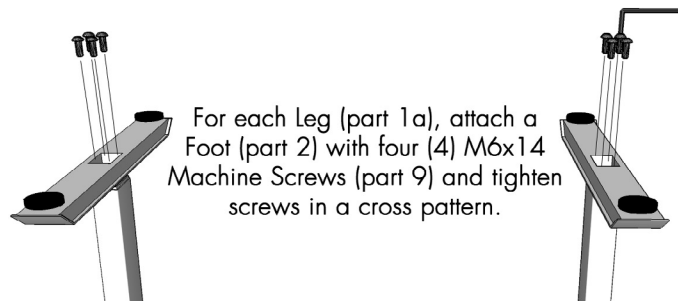

For each Leg (part 1 a), attach a Foot (part 2) with four (4) M6x14 Machine Screws (part 9) and tighten screws in a cross pattern.

# ASSEMBLY

**Note:** Instruction diagrams show a T-Leg style instead of the standard C-Leg style for the Deluxe Base.

Check both sides of the desktop before placing the desk base on the underside of the desktop. The desktop may or may not be pre-drilled.

Loosen the eight (8) pre-installed M6x10 Machine Screws (part 8) in the Frame-Leg Assembly (part 1).

6

Adjust the width of the desk base to fit the desktop by sliding the two halves outward. Lift and slide as to not damage the preinstalled rubber grommets.

We recommend leaving at least 1" of the desktop width (on each end) protruding beyond the frame width and centering the base fore and aft.

Lock the position of the Center Rails (parts 1d) by tightening the eight (8) pre-installed M6x10 Machine Screws (part 8).

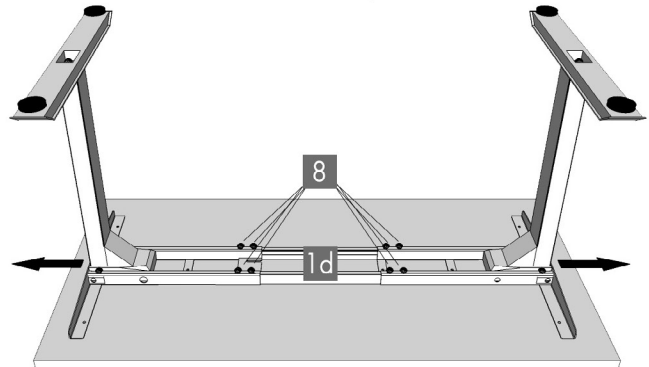

Ensure that the M6x10 Machine Screws contacts the Center Rails by sliding the Center Rails as needed.

⚠ Double-check that the wood screws are not too long for your desktop and won't puncture the surface when screwed all the way in. ⚠

Double-check that the desk base is properly positioned on the underside of the desktop.

7

Attach the desk base to the underside of the desktop using seven (7) M5x20 Wood Screws (part 10).

Attach the Handset (part 5) so the front of the handset is flush with the front desktop edge (or recessed up to 1/8"). The handset may be placed anywhere along the front edge of the desktop but we recommend placing it toward an end so it does not interfere with your chair when seated. Use two (2) M5x16 Wood Screws (part 11) to attach the handset to the desktop.

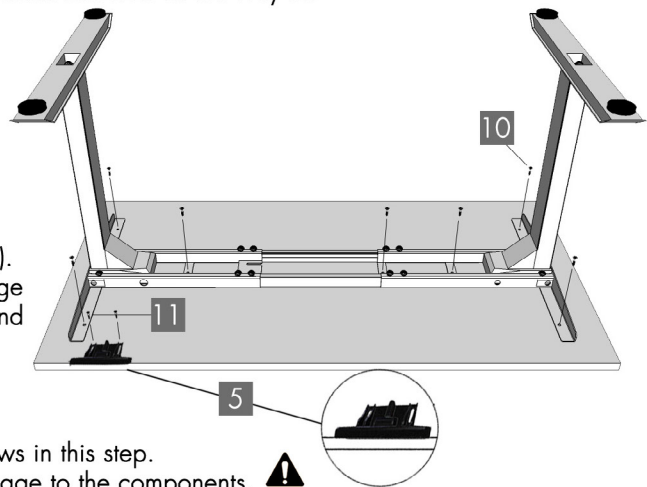

⚠ Do not overtighten screws in this step. Overtightening could cause damage to the components. ⚠

Slide the Control Box (part 4) onto the Frame End-CB (part 1c).

Connect the cable exiting the Leg (part 1a) that is attached to the Frame End-CB (part 1c) directly into the Control Box (part 4).

8

Connect the Cable (part 7) to the other Leg (part 1) and to the Control Box (part 4).

Connect the Handset (part 5) cable to the Control Box (part 4).

Connect the Power Cord (part 6) to the Control Box (part 4).

Use the adhesive-backed Cable Clips (part 12) to secure the cables so they do not sag. Attach the Wire Manager (part 13) to the underside of the desktop with M5x16 Wood Screws (part 11).

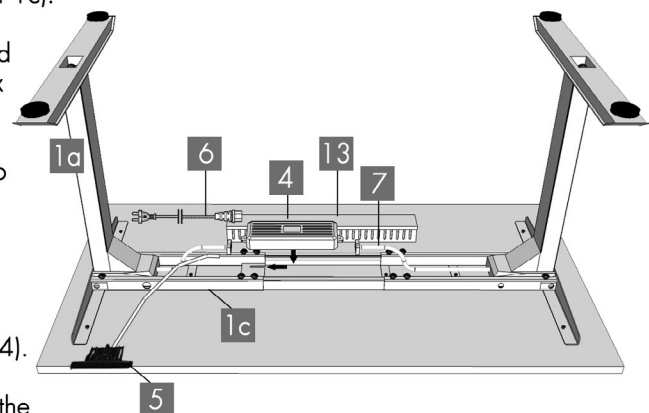

# ASSEMBLY

9 Turn the assembled desk right-side up. With at least two people, grab the DESK BASE (not the desktop) and turn the desk right-side up. Adjust the pre-installed glides on the Feet (part 2) as needed.

10 Plug the Power Cord (part 6) into a 110v outlet.

11 Run Reset Cycle before First Use (see USE Section).

# USE

**!** Make sure no obstacles are in the desk's path. **!** Make sure the desktop is not touching any walls. **!**  
Make sure all cords are appropriate length to accommodate the change in height.

IMPORTANT: You must RESET the desk prior to use.

## RESET PROCEDURE:

Press and hold the DOWN button on the Handset (part 5) until the desk reaches its lowest height. Release the DOWN button. Press and hold the DOWN button again until the LED display reads "RST". Release the DOWN button. Press and hold the DOWN button again until the desk lowers a little bit more, slightly rises and stops. Release the DOWN button. Your desk is now ready to use.

The desk base can be adjusted by pressing and holding either the UP or DOWN button until the desired height is reached.

To program up to four presets: Use the up/down buttons to find a desired height, then press "M" followed by a number 1 - 4.

CAUTION: Once a preset button is held, the desk will move to the programmed height (see caution box above).

# TROUBLESHOOTING

If your desk is not functioning properly it may need to be reset. Follow the RESET procedure outlined in the USE section.

If the LED readout displays an error message ("Er1" - "Er13") confirm that all wired connections are secure (legs to cables, cables to control box). Then perform the reset procedure outlined in the USE section.

If the error message persists after the reset procedure, contact Open Plan Systems at 844.OPS.OPS1 or by email at sales@openplan.com

If the height between the legs exceeds 1.5 inches, stop the reset procedure & contact Open Plan Systems

If the handset displays "HOT", let the base cool down for 20 minutes.

# SPECIFICATIONS

Height Range	23.5" - 49" (without desktop)
Base Width	42" min. - 74" max. (long) / 26" min - 45.8" max. (short)
Travel Speed	1.5" per second (no load)
Load Capacity	1000N
Duty Cycle	10%. Max. 2 mins on, 18 mins off
	Soft start/stop
	Adjustable glides
	4 Memory presets (some models)



# SETTING THE UPPER/LOWER LIMITS

The base is designed to go to its minimum and maximum heights, allowing for the widest possible range. If you prefer to change the settings to a more narrow range, follow these steps:

Make sure the power is ON and a number reads in the LED display (if no number appears, please follow the Reset procedure.)

## **To Set the Upper-Limit Position:**

Use the UP/DOWN buttons to move the base to the desired maximum height position. Press and hold the "M" button until the LED display flashes "S -" once and let go of the button. Then press the UP button once and the LED display will change to "999" then automatically return to the selected height. The new upper limit is now set.

## **To Set the Lower-Limit Position:**

Use the UP/DOWN buttons to move the base to the desired minimum height position. Press and hold the "M" button until the LED display flashes "S -" once and let go of the button. Then press the DOWN button once and the LED display will change to "000" then automatically return to the selected height. The new upper limit is now set.

## **To Remove the Upper/Lower Limit Positions:**

Use the UP or DOWN button to move the desk to any new position. Press and hold the "M" button until the LED display flashes "S -" once and let go of the button. Within 5 seconds, press the "M" button again and hold for 2 seconds. The LED will display "555", then automatically will return to the height display. The upper and lower limits are now removed.

Note: After the upper and lower limits are set, the previous memory positions (1, 2, 3, 4) may be outside the new range of movement. If so, simply reset the memory positions.

Note: A Reset procedure requires the desk base to fully retract (beyond any lower limit set). Please ensure that you have the proper clearance below the desk base.

Note: If you attempt to revise a previously set upper or lower limit and it is outside of the existing range, you will need to remove the previously set upper/lower limits first.

# SETTING THE LED DISPLAY RETRACTED HEIGHT

Press the DOWN button on the Switch until the base reaches its lowest position. Measure the height of the base from the floor and if the number on the LED display does NOT match your measurement, follow these steps:

Press and hold the DOWN button again until the LED display reads "RST". 

Press and hold the "M" button (about 5 seconds) until the LED displays the Hashing starting height. (If the display returns to "RST" before the next step is taken, repeat this step.)

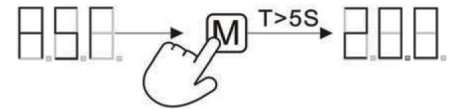

To change the value of the starting height:  
Increase by 0.1 s, press the UP button -----



Decrease by 0.1, press the DOWN button -----



Increase by 1 s, press the "1" button -----

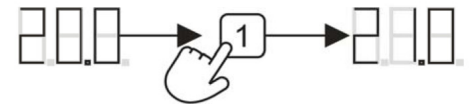

Decrease by 1 s, press the "2" button -----



Increase by 10s, press the "3" button -----

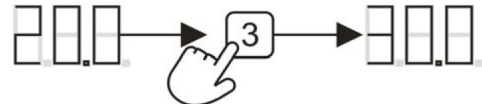

Decrease by 10s, press the "4" button -----



Once the new value is displayed, wait about 5 seconds and the display will return to "RST".   
Finish the reset process by pressing and holding the DOWN button again until the desk lowers a little bit more, slightly rises and stops. Release the DOWN button. The new starting height value is saved and your desk is now ready to use.

Note: the LED display has a  $\pm 0.1$  tolerance.