

SINGLE BASE

















POWERED ADJUSTABLE HEIGHT TABLE

ASSEMBLY & USE



SAFETY INFORMATION

CAUTION / INFORMATION

	Make sure no obstacles are in the desk's path. Make sure the desktop is not touching any walls. Make sure all cords are appropriate length to accommodate the change in height.			WARNING Pinch Point Keep hands and fingers clear.
	Keep children away from electric height-adjustable desks, control units and handsets. There is a risk of injury and electric shock.			
	Keep all electrical components away from liquids.			
	Do not sit or stand on the desk frame. Do not crawl or lie under the desk frame.			
	Do not place any objects taller than 25" underneath the desk.			
	Do not open any of the components - the Legs, Control Box, or Switch. There is a danger of electric shock.			
	This product is designed with a duty cycle of 10% (2 min. on, 18 min. off).			
	In the event of a power outage or if the power cord is unplugged, a manual reset may be necessary - see Step 8.			

USE / LIABILITY

This height adjustable desk has electric motors and is designed for use in dry work areas only. The desk height is adjustable so that it can be positioned at the most ergonomically suitable height.

Any other use is at user's risk.





Under no circumstances does the manufacturer accept warranty claims or liability claims for damages caused from improper use or handling of the desk frame.





ASSEMBLY

TOOLS REQUIRED

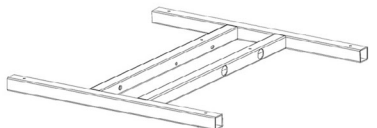



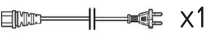

<p>4mm Hex Bit (optional)</p>  <p>4mm Allen Wrench (included)</p> 	 <p>Phillips Head Screwdriver and/or Power Drill</p>	 <p>Tape Measure</p>
--	---	---

COMPONENTS

<p>Leg</p>  <p>P1 x1</p>	<p>P2 x2 Foot</p>  <p>P3 x1 Crossbar (sm)</p>  <p>P4 x1 Crossbar (lg)</p> 	<p>Foot Plate</p>  <p>P5 x1</p>	<p>Top Mounting Frame</p>  <p>P6 x1</p>
---	---	---	--

<p>Control Box</p>  <p>P7 x1</p>	<p>Switch</p>  <p>P8 x1</p>	<p>P9 Power Cord</p>  <p>x1</p> <p>P10 LC Cable (43")</p>  <p>x1</p>
---	--	--

HARDWARE

<p>Machine Screw</p>  <p>M6x14</p> <p>P11 x22</p>	<p>Wood Screw</p>  <p>M5x16</p> <p>P12 x10</p>	<p>Cable Clip</p>  <p>P13 x3</p>	<p>Square Cap (preinstalled)</p>  <p>P14 x4</p>	<p>Round Cap</p>  <p>P15 x10</p>	<p>Noise Attenuation Pad</p>  <p>P16 x10</p>
--	---	---	---	---	---

PARTS DIAGRAM

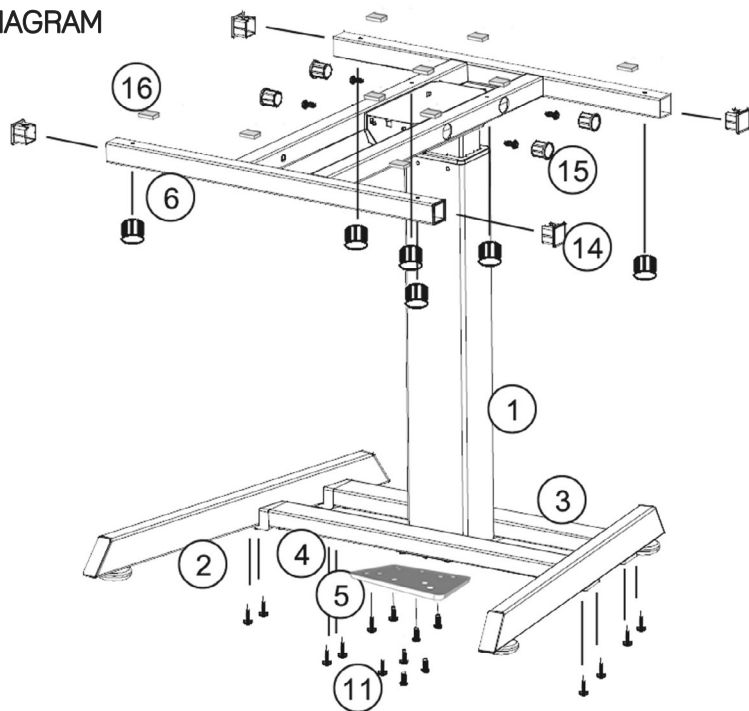

No.	Description	Qty
1	Leg	1
2	Foot with Glides	2
3	Crossbar (sm)	1
4	Crossbar (lg)	1
5	Foot Plate	1
6	Top Mount Frame	1
7	Control Box	1
8	Switch	1
9	Power Cord	1
10	LC Cable (43")	1
11	Machine Screw: M6x14	22
12	Wood Screw: M5x16	10
13	Cable Clip	3
14	Square Cap (preinstalled)	4
15	Round Cap	10
16	Noise Attenuation Pad	10

ASSEMBLY

- 1 Lay out all components and hardware to ensure that you have all the components and hardware listed on the parts page.

Using the supplied Allen Wrench, insert eight (8) M6x14 Machine Screws (P11) through the holes in the Crossbars (P3 & P4) going into the Feet (P1) and rotate each screw just a few turns.

The Crossbar (lg) is installed in front of the Crossbar (sm).

note: assembly these parts upside down as shown.

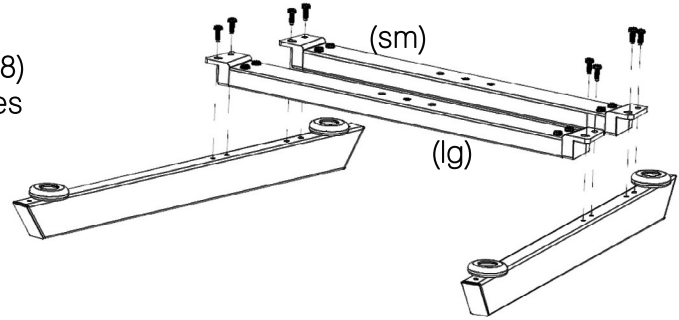

DO NOT tighten the screws at this point.



- 2 Using the supplied Allen Wrench, insert six (6) M6x14 Machine Screws (P11) through the holes in the Foot Plate (P5) going into Crossbars (P3 & P4) and rotate each screw just a few turns.



if you are having difficulty inserting any of the screws from Steps 1 or 2, it is because some of the installed screws are too tight.

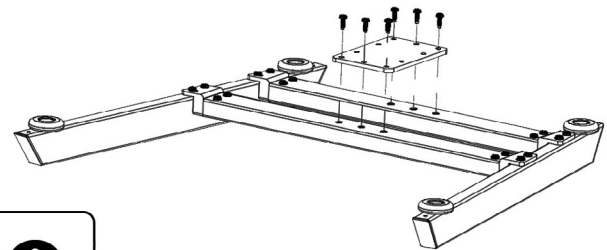

Once all the screws are inserted, tighten all the screws from Step 1 & Step 2.

- 3 Using the supplied Allen Wrench, insert four (4) M6x14 Machine Screws (P11) through the holes in Foot Plate (P5) going into the Leg (P1) and rotate each screw just a few turns.

Once all the screws are inserted, tighten all the screws in this Step.

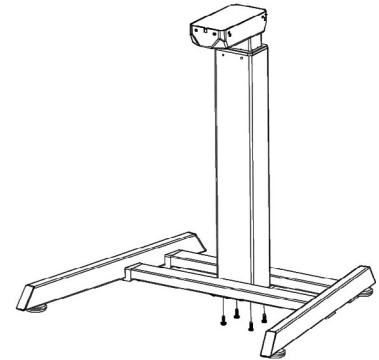

- 4 Using the supplied Allen Wrench, insert four (4) M6x14 Machine Screws (P11) through the holes in the Top Mounting Frame (P6) going into the top of the Leg (P1) and rotate each screw just a few turns.

Now tighten all the screws from this Step.

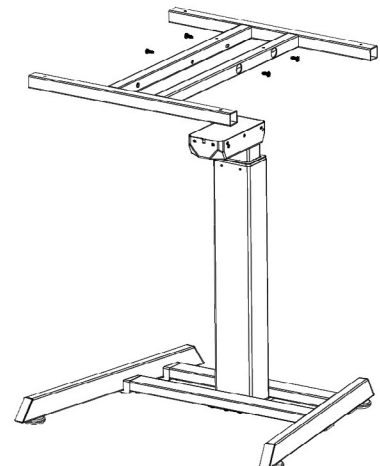



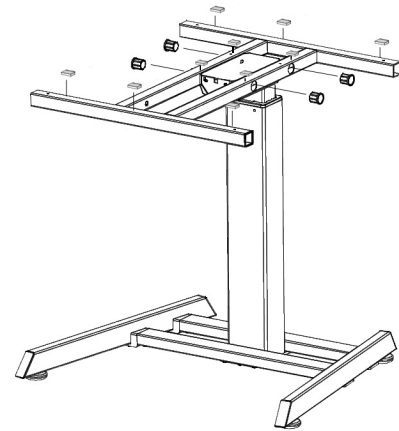

ASSEMBLY

- 5** Insert four (4) Round Caps (P15) in the Top Mounting Frame (P6) as shown.

Attach ten (10) Noise Attenuation Pads (P16) to the top of the Top Mounting Frame (P6) as shown.



- 6**  Double-check that the wood screws are not too long for your desktop and won't puncture the surface when screwed all the way in. 

 We recommend that you pre-drill any holes needed for fasteners connecting the Control Box (P7) or Switch (P8) to the desktop (if your desktop is not pre-drilled). Never use countersunk screws. 

Attach the Desktop to the Top Mounting Frame (P6) with six (6) M5x16 Wood Screws (P12) and then cover with six (6) Round Caps (P15).

Attach the Control Box (P7) to the underside of the desktop using two (2) M5x16 Wood Screws (P12). Ensure enough clearance at the wire ports for cable connections.

Place the Switch (P8) so the front of the Switch is flush with the front desktop edge (or recessed up to 1/8"). The Switch may be placed anywhere along the front edge of the desktop but we recommend placing it toward an end so it does not interfere with your chair when seated. Use two (2) M5x16 Wood Screws (P12) to attach the Switch to the desktop.

Adjust the four (4) Glides in the Foot (P1) as needed.

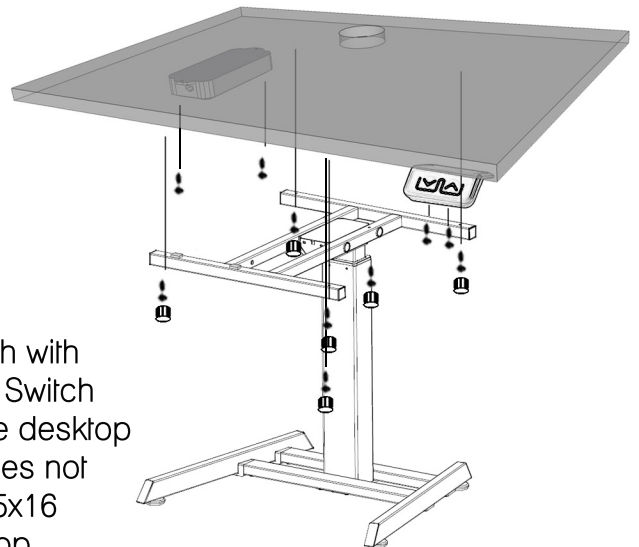

- 7** Connect the: LC Cable (P10), Switch Cable (P8), and the Power Cord (P9) to the Control Box (P7) as per the diagram. Use the adhesive-backed Cable Clips (P17) to secure the Cables and Switch cable so they don't sag.

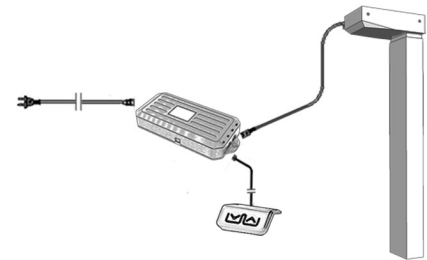

ASSEMBLY INSTRUCTIONS

8 Plug the Power Cord (P9) into a 110v outlet.



Make sure no obstacles are in the desk's path.
Make sure the desktop is not touching any walls.
Make sure all cords are appropriate length to accommodate
the change in height.



IMPORTANT: You must **RESET** the desk prior to use.

RESET PROCEDURE: Press and hold the DOWN button on the Switch (P8) until the desk reaches its lowest height. Release the DOWN button. Press and hold the DOWN button again about 10 seconds. Release the DOWN button. Press and hold the DOWN button again until the desk lowers a little bit more, slightly rises and stops. Release the DOWN button. Your desk is now ready to use.

TROUBLESHOOTING

If your desk is not functioning properly it may need to be reset. Confirm that all wired connections are secure (leg to cable, cable to control box, handset to control box). Then perform the reset procedure outlined in Step 8.

If the desk base does not perform correctly after the reset procedure, contact your seller.

TECHNICAL SPECIFICATIONS

Height Range	26.5" - 44.25" (without desktop)
Base Width	21.9"
Travel Speed	0.8" per second (no load)
Weight Capacity	176 lbs.
Duty Cycle	10%. Max. 2 mins on, 18 mins off
	Soft start/stop
	Adjustable leveling studs

SETTING THE UPPER/LOWER LIMITS

The base is designed to go to its minimum and maximum heights, allowing for the widest possible range. If you prefer to change the settings to a more narrow range, follow these steps:

Make sure the power is ON and a number reads in the LED display (if no number appears, please follow the Reset procedure.)

To Set the Upper-Limit Position:

Use the UP/DOWN buttons to move the base to the desired maximum height position. Press and hold the "M" button until the LED display flashes "S -" once and let go of the button. Then press and release the button 2 more times in quick succession. The LED display will change to "999" on the third push and then automatically return to the selected height. The new upper limit is now set.

To Set the Lower-Limit Position:

Use the UP/DOWN buttons to move the base to the desired minimum height position. Make sure the DOWN button was the last button you pushed. Press and hold the "M" button until the LED display flashes "S -" once and let go of the button. Then press and release the button 2 more times in quick succession. The LED display will change to "000" on the third push, and then automatically return to the selected height. The new upper limit is now set.

To Remove the Upper/Lower Limit Positions:

Use the UP or DOWN button to move the desk to any new position. Press and hold the "M" button until the LED display flashes "S -" once and let go of the button. Then press and release the button in succession until the display changes to "555" (ignore any interim readings) After a few seconds, the display automatically will change back to the numbered height position. The upper and lower limits are not removed.

Note: After the upper and lower limits are set, the previous memory positions (1, 2, 3, 4) may be outside the new range of movement. If so, simply reset the memory positions.

Note: A Reset procedure requires the desk base to fully retract (beyond any lower limit set). Please ensure that you have the proper clearance below the desk base.

Note: If you attempt to revise a previously set upper or lower limit and it is outside of the existing range, you will need to remove the previously set upper/lower limits first.