

# XPAND REACH

## Duplex- Rear Desk Mount – Assembly Instructions

### Tools Required



Cordless Drill

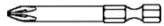

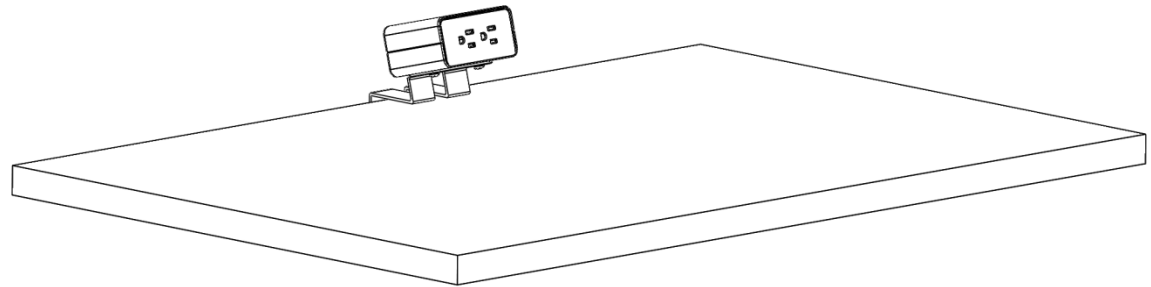

Phillips bit with extension  
for Work Surface screws  
(XP-Screw-WS)

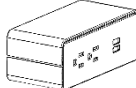

For additional assembly support, refer to [www.openplan.com](http://www.openplan.com)  
or contact 844.OPS.OPS1

# XPand Parts Used for Assembly

Item	Part name	Part Description	Image
1	XP-Duple-Clamp	Duplex Clamp Mount	
2	XP-SCREWS-WS	10-9X1 PH Pan Head, ST P'bd Screw, ZP	
3	XP-Duplex-XX-USB	Desktop Power Standard X Circuit	
4	XP-TXXXX	Work Surface	

XPand offers two types of Duplexes: Duplex-XX (Duplex without USB) and Duplex-XX-USB (Duplex with USB). When compared with Duplex-XX, Duplex-XX-USB is larger in size and has (2) USB ports. For the Rear Desk Mount application, the assembly Instructions are same for Duplex-XX and Duplex-XX-USB.

Step 1: Prepare a floor space to put the XPand order together. Unpack the parts and check to see if all the XPand parts are present as per the sales order pick list.

Step 2: Assemble XP-Duplex-Clamp to Duplex-XX-USB using (2) XP-Screw-WS. Use the holes on the Duplex-Clamp which are diagonal to each other.

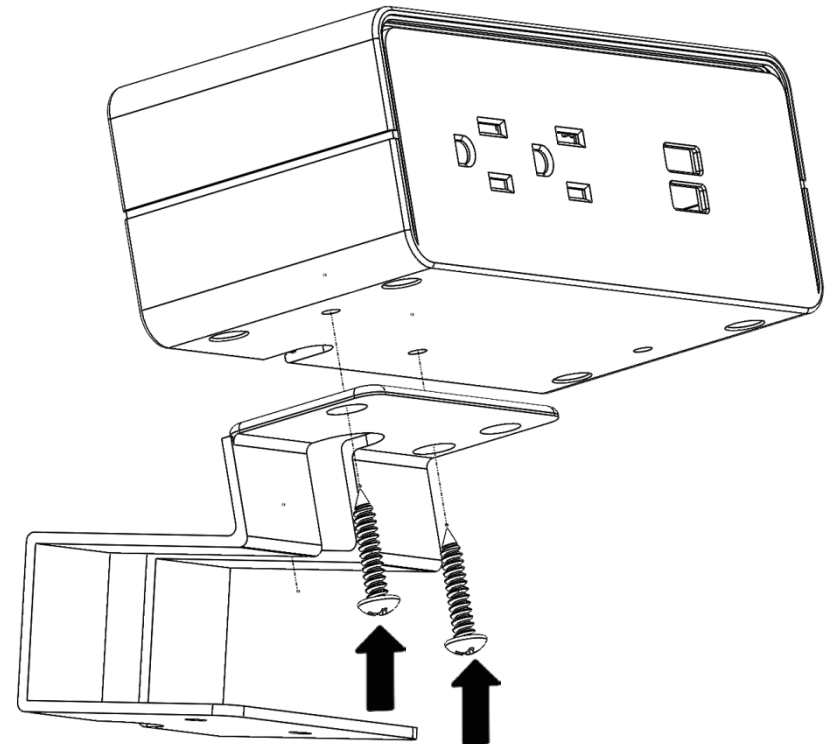
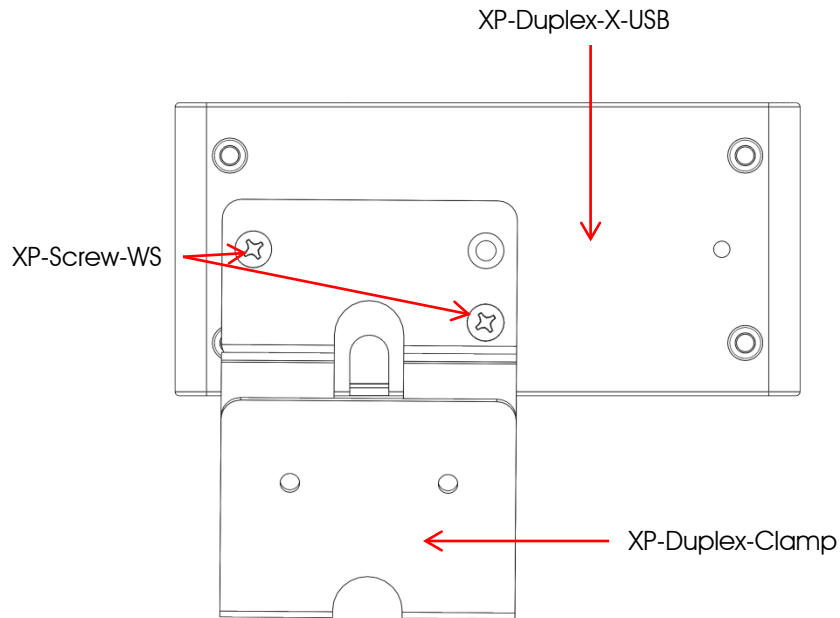

Step 3: Secure the assembled XP-Duplex-Clamp to the Work Surface using (2) XP-Screw-WS. Make sure the back end of the Duplex-Clamp is flush with the edge of the Work Surface.

